



ND3 Series Digital Indicator Lights

1. The purpose of use

1.1 ND3 series of digital indicator lights convert the analog signal in the process control system into a digital display to indicate various parameters of the signal, measurement and monitoring in the system. The product can indicate, measure and monitor the current, voltage, frequency, and temperature parameters. The products comply with the standard of IEC60947-5-1.

1.2 Standard: The product comply with IEC60947-5-1.

2. Type Designation

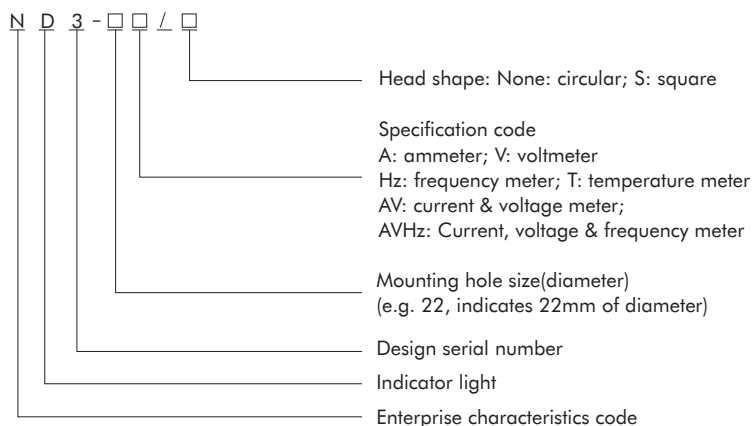











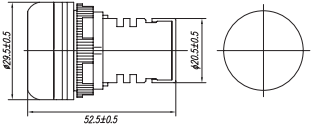

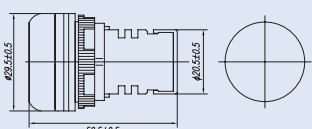

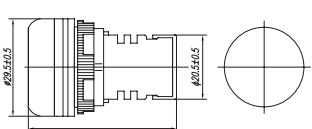

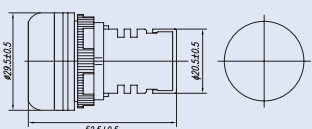
Note: 5 kinds of indicating color can be selected: red, yellow, green, blue, white

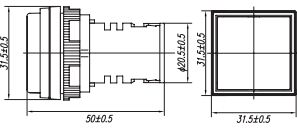
3. Technical data

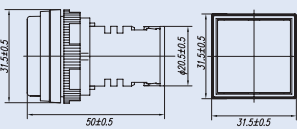
Rated operating voltage U_e (V)	AC50V~AC500V
Rated operating current I_e (mA)	≤50mA
Rated insulation voltage U_i (V)	660V
Rated impulse withstand voltage U_{imp} (kV)	2.5 kV
LED life span(h)	≥30000h
IP degree (head)	IP53 (circular) IP50 (square)
Allowable voltage fluctuation range	±10%
Voltage measurement range and accuracy	AC50V±2%~AC500V±2%
Current measurement range and accuracy	AC 0-100A(< 50A±1A, ≥50A±2%)
Frequency measurement range and accuracy	50Hz±2%~60Hz±2%
Temperature measurement range and accuracy	-20°C ±3°C ~199°C ±3°C
Normal operating temperature	-25°C ~ 70°C
Average temperature	No more than 35°C within 24h
Humidity	When the maximum temperature is 40°C, the relative humidity of the air does not exceed 50%
Altitude (m)	≤2000m
Pollution degree	3
Installation category	II
Installation conditions	Under the safety conditions, the installation area should be equipped with rain, snow and steam prevention facilities, and the signal light should be installed in a place with no significant shaking, shock and vibration and no conductive dust.
Transportation and storage conditions	The applicable temperature range for transport and storage is between -25°C to 70°C. The storage area shall be ventilated, dry and protected from rain, snow and direct sunlight.

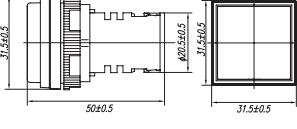
• Notice: This product is forbidden to be used in VFDs, inverters, and power environments with higher harmonic interference.

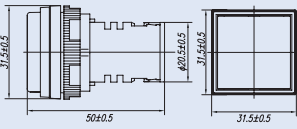
4. Specific model and detailed information

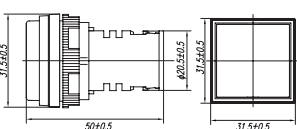
Shape	Description	Model type	Color	Main parameters	Dimensions
	Voltmeter	ND3-22V	<ul style="list-style-type: none"> ○ ● ● ● ● ● 	Ue:AC50V~AC500V In:≤ 50mA Measuring range:AC50V~AC500V	
	Ammeter	ND3-22A	<ul style="list-style-type: none"> ○ ● ● ● ● ● 	Ue:AC50V~AC500V In:≤ 50mA Measuring range:0-100A	
	Temperature meter	ND3-22T	<ul style="list-style-type: none"> ○ ● ● ● ● ● 	Ue:AC50V~AC500V In:≤ 50mA Measuring range:-20 °C ~199 °C	
	Current voltage meter	ND3-22AV	<ul style="list-style-type: none"> ○ ● ● ● ● ● 	Ue:AC50V~AC500V In:≤ 50mA Measuring range:0-100A Measuring range: AC50V~AC500V	
	Voltmeter	ND3-22V/S	<ul style="list-style-type: none"> ○ ● ● ● ● ● 	Ue:AC50V~AC500V In:≤50mA Measuring range:AC50V~AC500V	
	Ammeter	ND3-22A/S	<ul style="list-style-type: none"> ○ ● ● ● ● ● 	Ue : AC50V~AC500V In : ≤ 50mA Measuring range:0-100A	
	Temperature meter	ND3-22T/S	<ul style="list-style-type: none"> ○ ● ● ● ● ● 	Ue:AC50V~AC500V In :≤ 50mA Measuring range:-20 °C ~199 °C	
	Current voltage meter	ND3-22AV/S	<ul style="list-style-type: none"> ○ ● ● ● ● ● 	Ue:AC50V~AC500V In:≤ 50mA Measuring range:0-100A Measuring range:AC50V~AC500V	
	Current,voltage meter & frequency	ND3-22AVHz/S	<ul style="list-style-type: none"> ○ ● ● ● ● ● 	Ue: AC50V~AC500V In: ≤50mA Measuring range: 0~100A Measuring range: AC50V~AC500V Measuring range: 50Hz~60Hz	

5. Installation and operations

5.1 Product installation introduction

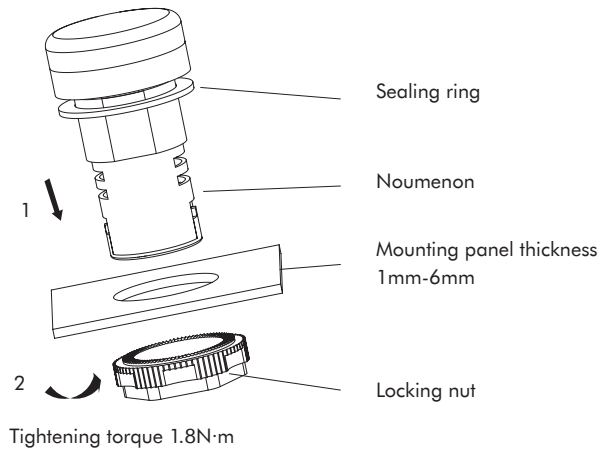

5.2 Wiring and tightening torque selection

Terminal tightening torque N.m	Cable (hard)mm ²	Cable (soft)mm ²	Remark
			1.Use hard or flexible cable for single wires connection 2.A terminal can be connected with two cables of same cross section or same type. 3.The strip length is 8mm
M3.5(0.8)	2×(0.5-1.0)	2×(0.5-1.0)	

5.3 Wiring diagram

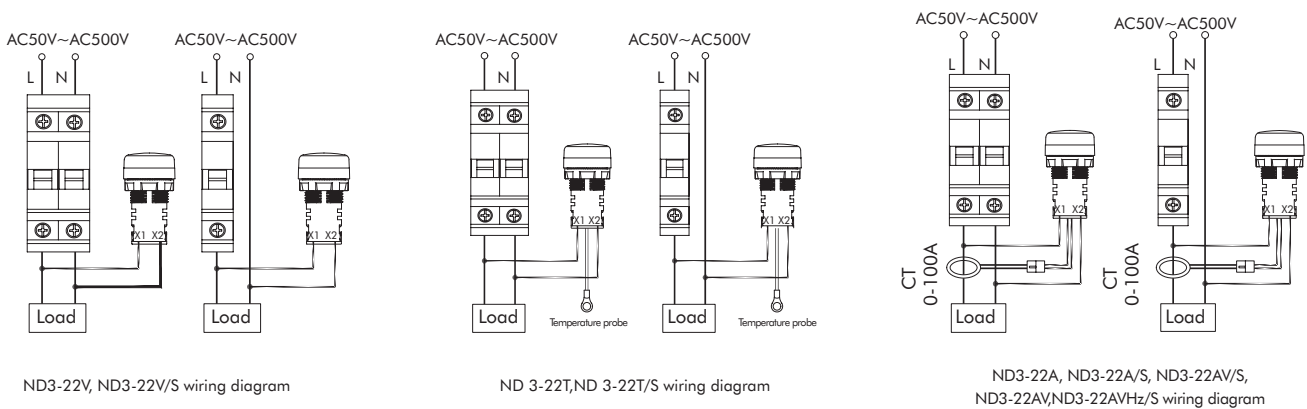

6. Ordering Information

When ordering, please specify the model specifications, the color and quantity, such as: ND3-22A red 20pcs; ND3-22AVHz/S yellow 20pcs .

Indication function	Shape of the head	Color	Model Description	Code
Current	Round	Blue	ND3-22A BLU	508950
Current	Round	Green	ND3-22A GRN	508949
Current	Round	Red	ND3-22A RED	508947
Current	Round	White	ND3-22A WHT	508951
Current	Round	Yellow	ND3-22A YEL	508948
Current	Square	Blue	ND3-22A/S BLU	508955
Current	Square	Green	ND3-22A/S GRN	508954
Current	Square	Red	ND3-22A/S RED	508952
Current	Square	White	ND3-22A/S WHT	508956
Current	Square	Yellow	ND3-22A/S YEL	508953
Current and voltage	Round	Blue	ND3-22AV Blue	513315
Current and voltage	Round	Green	ND3-22AV Green	513314
Current and voltage	Round	Red	ND3-22AV Red	513312
Current and voltage	Round	White	ND3-22AV White	513316
Current and voltage	Round	Yellow	ND3-22AV Yellow	513313
Current and voltage	Square	Blue	ND3-22AV/S BLU	508980
Current and voltage	Square	Green	ND3-22AV/S GRN	508979
Current and voltage	Square	Red	ND3-22AV/S RED	508977
Current and voltage	Square	White	ND3-22AV/S WHT	508981
Current and voltage	Square	Yellow	ND3-22AV/S YEL	508978
Current, voltage and frequency	Square	Blue	ND3-22AVHz/S BLU	508985
Current, voltage and frequency	Square	Green	ND3-22AVHz/S GRN	508984
Current, voltage and frequency	Square	Red	ND3-22AVHz/S RED	508982
Current, voltage and frequency	Square	White	ND3-22AVHz/S WHT	508986
Current, voltage and frequency	Square	Yellow	ND3-22AVHz/S YEL	508983
Temperature	Round	Blue	ND3-22T BLU	508970
Temperature	Round	Green	ND3-22T GRN	508969
Temperature	Round	Red	ND3-22T RED	508967
Temperature	Round	White	ND3-22T WHT	508971
Temperature	Round	Yellow	ND3-22T YEL	508968
Temperature	Square	Blue	ND3-22T/S BLU	508975
Temperature	Square	Green	ND3-22T/S GRN	508974
Temperature	Square	Red	ND3-22T/S RED	508972
Temperature	Square	White	ND3-22T/S WHT	508976
Temperature	Square	Yellow	ND3-22T/S YEL	508973
Voltage	Round	Blue	ND3-22V BLU	508960
Voltage	Round	Green	ND3-22V GRN	508959
Voltage	Round	Red	ND3-22V RED	508957
Voltage	Round	White	ND3-22V WHT	508961
Voltage	Round	Yellow	ND3-22V YEL	508958
Voltage	Square	Blue	ND3-22V/S BLU	508965
Voltage	Square	Green	ND3-22V/S GRN	508964
Voltage	Square	Red	ND3-22V/S RED	508962
Voltage	Square	White	ND3-22V/S WHT	508966
Voltage	Square	Yellow	ND3-22V/S YEL	508963